

INSTALLATION INSTRUCTIONS

8.9W TYPE B T8 LED TUBES | 4 FT. SINGLE-ENDED OR DOUBLE-ENDED



WARNINGS

THIS PRODUCT MUST BE INSTALLED IN ACCORDANCE WITH THE APPLICABLE INSTALLATION CODE BY A PERSON FAMILIAR WITH THE CONSTRUCTION AND OPERATION OF THE PRODUCT AND THE HAZARDS INVOLVED.

- **WARNING** - Risk of fire or electric shock. LED Reflector kit installation requires knowledge of luminaires electrical systems. If not qualified, do not attempt installation. Contact a qualified electrician.
- **WARNING** – Risk of fire or electric shock. Install this kit only in luminaires that have the construction features and dimensions shown in the photographs and/or drawings and where the input rating of the retrofit kit does not exceed the input rating of the luminaire.
- Do not make or alter any open holes in an enclosure of wiring or electrical components during kit installation.
- To prevent wiring damage or abrasion, do not expose wiring to edges of sheet metal or other sharp objects.
- Installers should not disconnect existing wires from lamp holder terminals to make new connections at lamp holder terminals. Instead, installers should cut existing lamp holder leads away from the lamp holder and make new electrical connections to lamp holder lead wires by employing applicable connectors.
- Suitable for damp locations.
- Do not use with dimmers.
- **ONCE THE LUMINAIRE IS MODIFIED AS A RETROFIT FIXTURE IT WILL NO LONGER OPERATE FLUORESCENT LAMPS.**

PLEASE KEEP THIS QUICK INSTALLATION GUIDE FOR FUTURE REFERENCE. MODIFICATIONS TO THE PRODUCT VOID THE WARRANTY. SUITABLE TO REPLACE FLUORESCENT LAMPS AS SPECIFIED ON THE PRODUCT LABEL.

1. DISCONNECT LUMINAIRE POWER

Disconnect luminaire power or circuit (if possible). Ensure all power is off by using a voltmeter or other method to confirm.

2. REMOVE EXISTING TUBE LAMP(S)

- a. Remove troffer lens, if present.
- b. Remove existing fluorescent lamps by rotating one quarter turn and sliding out.
- c. Remove ballast cover. Cover may be secured with screws or tabs.

INSTALLATION INSTRUCTIONS

8.9W TYPE B T8 LED TUBES | 4 FT. SINGLE-ENDED OR DOUBLE-ENDED

3. Retrofit Luminaire

3.1 Wiring:

a. Retrofit luminaire with inductive ballast. (*Single-Ended Tube*)

1) Disconnect the wires between starter and ballast according to the figure below.

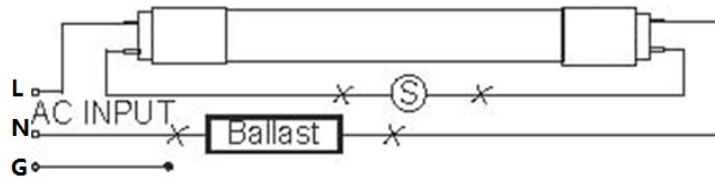

2) Connect two wires to branch circuit L and N according to the figure below.

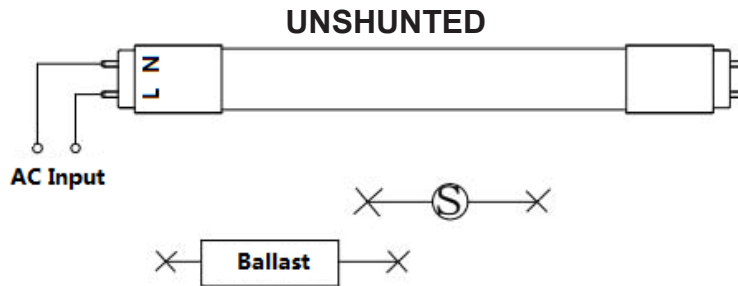

b. Retrofit luminaire with electronic ballast. (*Double-Ended Tube*)

1) Disconnect the wires between starter and ballast according to the figure below.

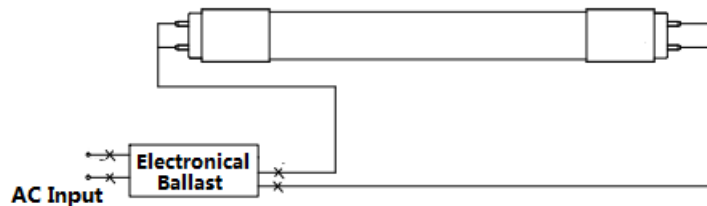

2) Connect two wires to branch circuit L and N according to the figure below.

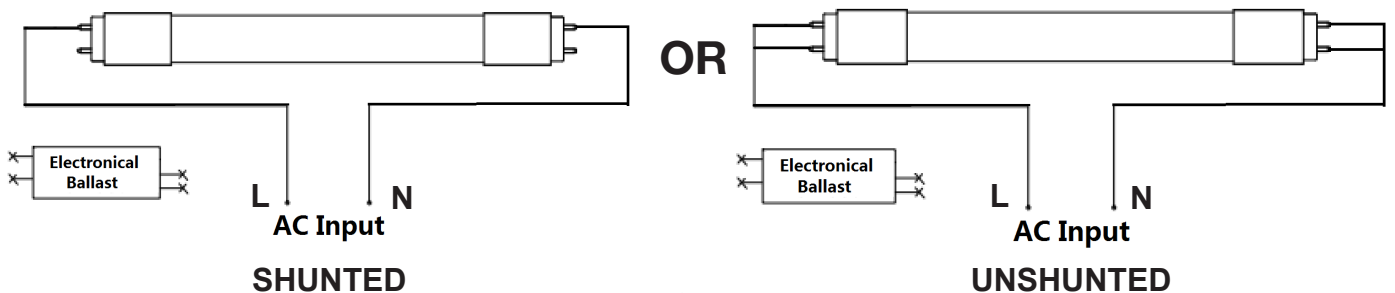

INSTALLATION INSTRUCTIONS

8.9W TYPE B T8 LED TUBES | 4 FT. SINGLE-ENDED OR DOUBLE-ENDED

c. Retrofit luminaire with two lamps and one electronic ballast. (*Single-Ended Tube*)

- 1) Disconnect the wires between starter and ballast according to the figure below.

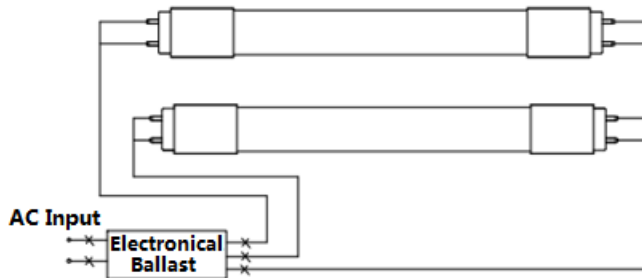

- 2) Connect two wires to branch circuit L and N according to the figure below.

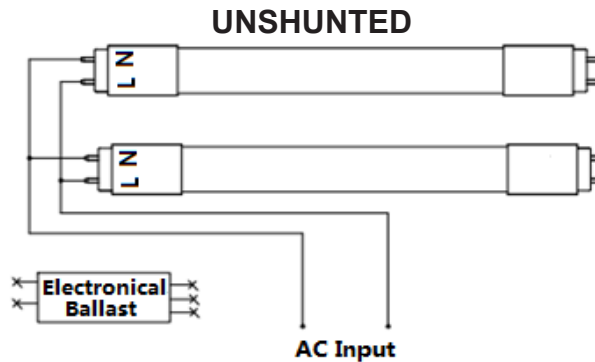

d. Retrofit luminaire with two lamps and one electronic ballast. (*Double-Ended Tube*)

- 1) Disconnect the wires between starter and ballast according to the figure below.

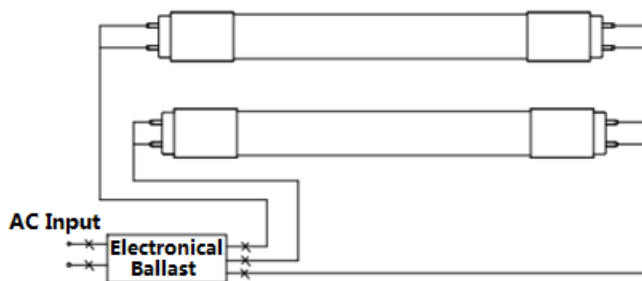

- 2) Connect two wires to branch circuit L and N according to the figure below.

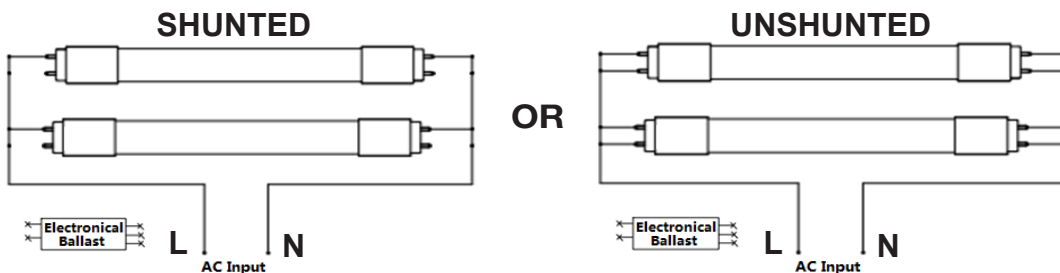

INSTALLATION INSTRUCTIONS

8.9W TYPE B T8 LED TUBES | 4 FT. SINGLE-ENDED OR DOUBLE-ENDED

4. Insert LED Tubes

- a. Read label on the LED tube to ensure the power end of LED is aligned with powered tube socket, then insert LED lamp in the normal way by sliding pins into sockets and rotating a quarter turn until LED tube locks in place.
- b. LED lamps are now fully installed. Replace troffer lens if present.
- d. After modification completed, attach the Replacement Marking and Cautionary Label to a visible place on the luminaire and keep it visible after installation.

5. Restore Power To The Luminaire

Restore power to circuit/luminaire and test light. If necessary, adjust position of LED tubes.