

RightChoice

RCAL1 | LED Area/Site Lighting with Selectable CCT



Key Features

- Best-in-class outdoor lighting solution that ensures outstanding performance and value.
- Sleek aesthetic presents a modern appearance for sites and is night sky friendly.
- Easy installation by one person in the field.
- Optional rotatable optics provide design flexibility for unique aspects of a site plan to deliver light exactly where it's needed.
- Selectable correlated color temperature (CCT) with integrated switch.

Electrical

- 120-277VAC or 277-480VAC; 50/60Hz input.
- IP65 rated Class 2 driver; 0-10V dimming standard.
- 10kV surge protection standard; 20kV option also available.
- System power factor >90% and THD ≤20%.
- Operating temperature: -40°C to 50°C (-40°F to 122°F).

Mounting

- Slip fitter, pole mount, or trunnion mounting options available.

Construction

- Die-cast aluminum housing protects integral components from harsh environments and optimizes thermal management.
- Housing is protected by a corrosion resistant powder coat available in standard bronze, white or black finish. Consult factory for custom color options.
- IP65 rated enclosure prevents intrusion from environmental elements that could degrade performance.

Optics

- IP65 rated LED light engine prevents dust or moisture from degrading performance.
- Precision molded optics: IES Type II, Type III, Type IV, or Type V distributions. Optional rotatable optics available (consult factory).
- Industry-leading LEDs with selectable CCT: 3000K, 4000K, and 5000K CCT (min. 80 CRI).
- Lumen Maintenance: ≥167,000 hours (L70) ¹

Warranty

- Backed by US LED's industry-leading Ten-Year Warranty.

Project	Date
---------	------

Catalog Number	Type
----------------	------

Product Performance Summary

Lumen Output	Up to 47,318 lumens
Efficacy	Up to 158 LPW
CRI	≥ 80 CRI
Available CCT	Selectable CCT 3000K, 4000K & 5000K
Warranty	Ten-Year Warranty

Product Overview

The contemporary styling of the Right Choice Series (RCAL1) presents an attractive aesthetic that incorporates seamlessly with the existing architecture. It provides all the benefits of advanced LED technology, including selectable CCT, into a high-performing, ultra-long-life outdoor luminaire. Best-in-class photometric performance ensures exceptional uniformity and optimal pole spacing. With multiple lumen packages and mounting options, the RCAL can be a complete lighting solution for any outdoor application.

Product Applications

- Auto Dealerships
- Retail Parking Lots
- Educational Facilities
- Business Campuses
- Recreational Areas
- Industrial Facilities
- Security Areas
- Site Pathway Areas

Product Certifications

- UL Listed
- Complies with UL1598 and CSA C22.2
- DLC Premium Listed
- Suitable for Wet Locations (IP65 Rated)
- RoHS Compliant



Ordering Information

Example: RCAL1-30-SCCT-UNVL-1-3-10SP-Z5 200 N

RCAL1	Series	Size ²	Selectable CCT	Input Voltage	Finish	Optics	Surge Protect	Product Code	Z5
	15	SCCT	Selectable CCT: 3000K, 4000K, & 5000K	UNVL 120-277V	1 Bronze	2 Type 2	10SP 10kV		
	30			UNVH 277-480V	2 White	3 Type 3	20SP 20kV		
					3 Black	4 Type 4			
						5 Type 5			

Wattage	Options
100 100W	N No Photocell
120 120W	D1 Photocell
150 150W	D2 Motion Sensor
200 200W	
250 250W	
300 300W	

Mounting Accessories	
Example: ADM-B	
Mounting	Finish
DM Adjustable Square and Round Pole - 4" Nominal	B Bronze
AM Slip Fitter	W White
YM Trunnion	BK Black
ADM 2 3/8" Round Tenon	
Shielding Accessories	
Shielding	Finish
BLS Back Light Shield	B Bronze
HSS House Side Shield	W White
	BK Black

1. US LED product 'Lifetimes' refer only to the LED light engine, not the power source, and are based on the Illuminating Engineering Society's TM21 Reported Lumen Maintenance methodology at a 25° C / 77° F ambient temperature. The lifetimes are solely meant to be a guide for expected LED degradation and not a warranty or predictive of their actual life, which can be affected by ambient temperatures and other factors.
2. Size 15 (100W/120W/150W) and Size 30 (200W/250W/300W).

Dimensions

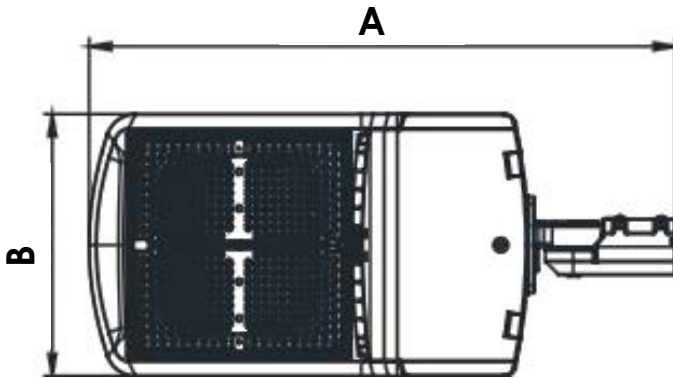

Size	A	B	C	Net Weight	EPA Rating
15	27.50 in.	11.40 in.	3.00 in.	9.60 lbs.	1.70 ft. ²
30	31.46 in.	14.01 in.	3.00 in.	15.9 lbs.	2.70 ft. ²



Size	Mounting	Net Weight	Carton Size	Size	Mounting	Net Weight	Carton Size
15	AM Adjustable Slip Fitter	11.88 lbs.	29.53 in. x 13.19 in. x 6.30 in.	30	AM Adjustable Slip Fitter	17.39 lbs.	34.25 in. x 15.94 in. x 6.30 in.
	DM 4" Square/Round Pole	13.20 lbs.	29.53 in. x 13.19 in. x 6.30 in.		DM 4" Square/Round Pole	18.70 lbs.	34.25 in. x 15.94 in. x 6.30 in.
	ADM 2 3/8" Round Tenon	12.98 lbs.	29.53 in. x 13.19 in. x 6.30 in.		ADM 2 3/8" Round Tenon	18.48 lbs.	34.25 in. x 15.94 in. x 6.30 in.
	YM Trunnion Mount	11.22 lbs.	29.53 in. x 13.19 in. x 6.30 in.		YM Trunnion Mount	16.72 lbs.	34.25 in. x 15.94 in. x 6.30 in.

Performance Data

Size	Model	Distribution	Wattage	Lumen Output	Efficacy	BUG Rating	Selectable CCT	L70 Calculated Life
15	100W	Type 2	100.0W	15,772.0	157.7 LPW	B3-U0-G3	3000K/4000K/5000K	≥167,000 Hours
		Type 3	100.0W	15,083.0	150.8 LPW	B3-U0-G3	3000K/4000K/5000K	≥167,000 Hours
		Type 4	100.0W	15,129.0	151.3 LPW	B3-U3-G3	3000K/4000K/5000K	≥167,000 Hours
		Type 5	99.3W	15,063.0	151.7 LPW	B4-U0-G3	3000K/4000K/5000K	≥167,000 Hours
	120W	Type 2	120.0W	18,926.0	157.7 LPW	B3-U0-G3	3000K/4000K/5000K	≥167,000 Hours
		Type 3	120.0W	18,103.0	150.9 LPW	B3-U0-G3	3000K/4000K/5000K	≥167,000 Hours
		Type 4	120.0W	18,556.0	154.6 LPW	B3-U3-G3	3000K/4000K/5000K	≥167,000 Hours
		Type 5	119.6W	17,963.0	150.2 LPW	B4-U0-G3	3000K/4000K/5000K	≥167,000 Hours
	150W	Type 2	154.0W	23,658.0	153.6 LPW	B3-U0-G3	3000K/4000K/5000K	≥167,000 Hours
		Type 3	145.8W	21,890.0	150.1 LPW	B3-U0-G3	3000K/4000K/5000K	≥167,000 Hours
		Type 4	150.0W	23,195.0	154.6 LPW	B3-U3-G3	3000K/4000K/5000K	≥167,000 Hours
		Type 5	145.9W	21,817.0	149.5 LPW	B4-U0-G3	3000K/4000K/5000K	≥167,000 Hours
30	200W	Type 2	200.0W	30,094.0	150.5 LPW	B4-U0-G4	3000K/4000K/5000K	≥167,000 Hours
		Type 3	200.0W	30,012.0	150.5 LPW	B4-U0-G4	3000K/4000K/5000K	≥167,000 Hours
		Type 4	200.0W	29,875.0	149.4 LPW	B4-U3-G4	3000K/4000K/5000K	≥167,000 Hours
		Type 5	200.0W	30,299.0	151.5 LPW	B4-U0-G4	3000K/4000K/5000K	≥167,000 Hours
	250W	Type 2	250.0W	37,618.0	150.5 LPW	B4-U0-G4	3000K/4000K/5000K	≥167,000 Hours
		Type 3	250.0W	37,651.0	150.6 LPW	B4-U0-G4	3000K/4000K/5000K	≥167,000 Hours
		Type 4	249.0W	37,272.0	149.6 LPW	B4-U3-G4	3000K/4000K/5000K	≥167,000 Hours
		Type 5	249.2W	38,241.0	153.5 LPW	B4-U0-G4	3000K/4000K/5000K	≥167,000 Hours
	300W	Type 2	302.1W	45,443.0	150.4 LPW	B4-U0-G4	3000K/4000K/5000K	≥167,000 Hours
		Type 3	298.6W	44,656.0	149.6 LPW	B5-U0-G4	3000K/4000K/5000K	≥167,000 Hours
		Type 4	299.2W	47,318.0	158.1 LPW	B5-U3-G5	3000K/4000K/5000K	≥167,000 Hours
		Type 5	299.8W	45,056.0	150.3 LPW	B5-U0-G4	3000K/4000K/5000K	≥167,000 Hours

Optical Distributions

All photometric testing performed to IESNA LM-79 standards by a NVLAP® accredited testing facility. ISO footcandle plots below demonstrate examples of the general distribution patterns based on a 25' mounting height. Please visit www.usled.com for complete specifications, IES files, and detailed photometric data.

Type II Distribution

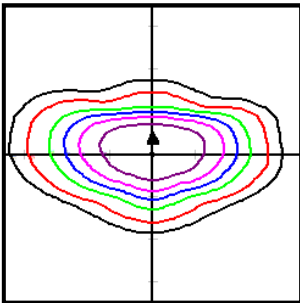

Type II distribution forms a wide, lateral asymmetric pattern typically used for applications needing narrow lighting. Examples might include car lot front rows, walkways, side streets, jogging paths, and entrances from the roadway.

Type III Distribution

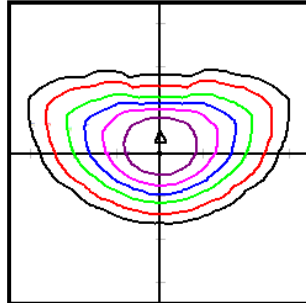

Type III distribution projects light evenly and equally forward on both sides in an "asymmetric" pattern. Commonly used in parking lots, wider roadways, and other applications where a larger area of lighting is required.

Type IV Distribution

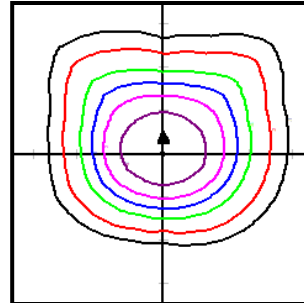

Type IV distribution is intended to maximize the amount of light going forward in a longer "semicircular" pattern. This optic is used around the perimeters of parking lots where there is no desire for wasted light behind the pole. It's also used for sport applications and parking areas on the sides of buildings.

Type V Distribution

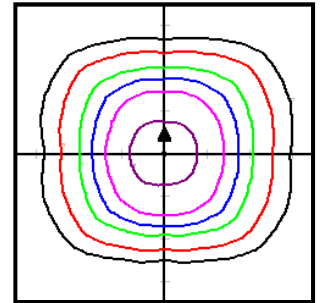

Type V distribution forms a symmetrical round or square pattern that allows the light to have the same intensity at all angles. Primarily used in parking lot interiors, crossroads, and roadway centers. It is also meant for large commercial parking lots where evenly distributed lighting is necessary.

The RCAL's optional rotatable optics offer versatility to design around the specific characteristics of the site layout rather than being constrained by the limitations of the LED luminaire. It's recommended that US LED create a photometric layout that specifies luminaire placement and indicates where rotatable optics are applied.

90° Left Orientation Top View

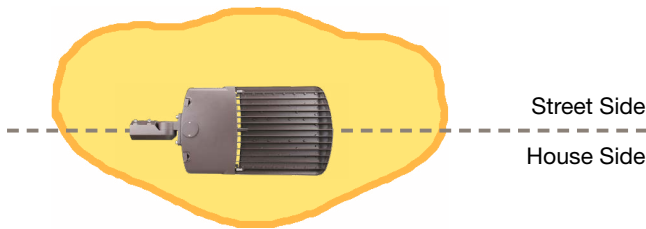

90° Right Orientation Top View

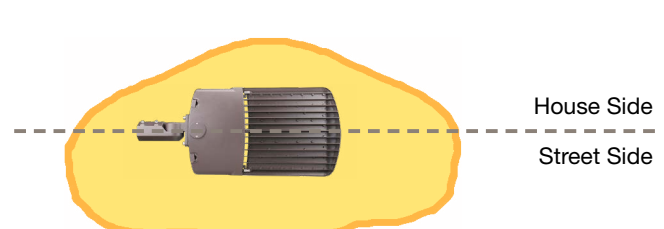

Mounting Accessories

DM | Mount for Square Pole & Round Pole - 4" Nominal



YM | Trunnion Mount



AM | Adjustable Slip Fitter Mount



ADM | Mount For 2 3/8" Round Tenon



Right Choice

RCAL2 | LED Area/Site Lighting



Key Features

- Best-in-class outdoor lighting solution that ensures outstanding performance and value.
- Sleek aesthetic presents a modern appearance for sites and is night sky friendly.
- Easy installation by one person in the field.
- Optional rotatable optics provide design flexibility for unique aspects of a site plan to deliver light exactly where it's needed.
- High output with precise optical control.

Electrical

- 120-277VAC or 277-480VAC; 50/60Hz input.
- IP65 rated Class 2 driver; 0-10V dimming standard.
- 10kV surge protection standard; 20kV option also available.
- System power factor >90% and THD ≤20%.
- Operating temperature: -40°C to 50°C (-40°F to 122°F).

Mounting

- Slip fitter, pole mount, or trunnion mounting options available (sold separately).

Construction

- Die-cast aluminum housing protects integral components from harsh environments and optimizes thermal management.
- Housing is protected by a corrosion resistant powder coat available in standard bronze, white or black finish. Consult factory for custom color options.
- IP65 rated enclosure prevents intrusion from environmental elements that could degrade performance.

Optics

- IP65 rated LED light engine prevents dust or moisture from degrading performance.
- Precision molded optics: IES Type II, Type III, Type IV, or Type V distributions. Optional rotatable optics available (consult factory).
- Industry-leading LEDs with 3000K, 4000K, and 5000K CCT (minimum 80 CRI).
- Lumen Maintenance: ≥167,000 hours (L70) ¹

Warranty

- Backed by US LED's industry-leading Ten-Year Warranty.

Project	Date
---------	------

Catalog Number	Type
----------------	------

Product Performance Summary

Lumen Output	Up to 77,642 lumens
Efficacy	Up to 154 LPW
CRI	≥ 80 CRI
Available CCT	3000K, 4000K & 5000K
Warranty	Ten-Year Warranty

Product Overview

The contemporary styling of the Right Choice Series (RCAL2) presents an attractive aesthetic that incorporates seamlessly with the existing architecture. It provides all the benefits of advanced LED technology into a high-performing, ultra-long-life outdoor luminaire with high output capabilities. Best-in-class photometric performance ensures exceptional uniformity and optimal pole spacing. With multiple lumen packages and mounting options, the RCAL can be a complete lighting solution for any outdoor application.

Product Applications

- Auto Dealerships
- Retail Parking Lots
- Educational Facilities
- Business Campuses
- Recreational Areas
- Industrial Facilities
- Security Areas
- Site Pathway Areas

Product Certifications

- UL Listed
- Complies with UL1598 and CSA C22.2
- DLC Premium Listed
- Suitable for Wet Locations (IP65 Rated)
- RoHS Compliant



Ordering Information

Example: RCAL2-37-50-UNVL-1-3-10SP-Z5 N

RCAL2	Series	Size	CCT	Input Voltage	Finish	Optics	Surge Protect	Product Code	Options
	37	375W	30 3000K	UNVL 120-277V	1 Bronze	2 Type 2	10SP 10kV	Z5	N No Photocell
	50	500W	40 4000K	UNVH 277-480V	2 White	3 Type 3	20SP 20kV		D1 Photocell
			50 5000K		3 Black	4 Type 4			D2 Motion Sensor
						5 Type 5			

Mounting Accessories	
Example: ADM-B	
Mounting	Finish
DM Adjustable Square and Round Pole - 4" Nominal	B Bronze
AM Slip Fitter	W White
YM Trunnion	BK Black
ADM 2 3/8" Round Tenon	
Shielding Accessories	
Shielding	Finish
BLS Back Light Shield	B Bronze
HSS House Side Shield	W White
	BK Black

1. US LED product 'Lifetimes' refer only to the LED light engine, not the power source, and are based on the Illuminating Engineering Society's TM21 Reported Lumen Maintenance methodology at a 25° C / 77° F ambient temperature. The lifetimes are solely meant to be a guide for expected LED degradation and not a warranty or predictive of their actual life, which can be affected by ambient temperatures and other factors.

Dimensions

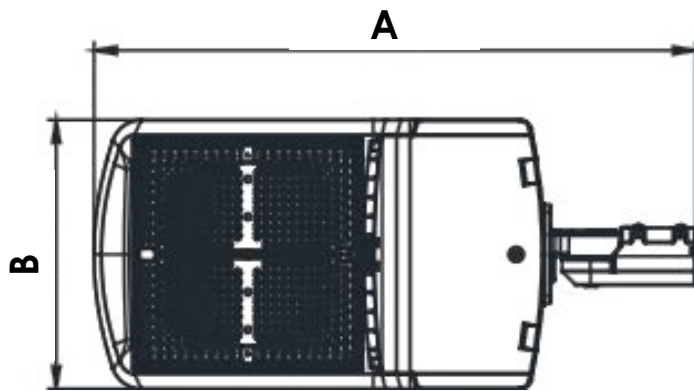

Size	A	B	C	Net Weight	EPA Rating
37	31.46 in.	14.01 in.	3.00 in.	14.65 lbs.	2.70 ft. ²
50	32.9 in.	15.28 in.	3.00 in.	20.90 lbs.	2.76 ft. ²



Size	Mounting	Net Weight	Carton Size
37	AM Adjustable Slip Fitter	16.85 lbs.	34.25 in. x 15.94 in. x 6.30 in.
	DM 4" Square/Round Pole	18.17 lbs.	34.25 in. x 15.94 in. x 6.30 in.
	ADM 2 3/8" Round Tenon	17.95 lbs.	34.25 in. x 15.94 in. x 6.30 in.
	YM Trunnion Mount	16.41 lbs.	34.25 in. x 15.94 in. x 6.30 in.
50	AM Adjustable Slip Fitter	23.10 lbs.	36.02 in. x 18.11 in. x 6.30 in.
	DM 4" Square/Round Pole	24.20 lbs.	36.02 in. x 18.11 in. x 6.30 in.
	ADM 2 3/8" Round Tenon	23.98 lbs.	36.02 in. x 18.11 in. x 6.30 in.
	YM Trunnion Mount	22.22 lbs.	36.02 in. x 18.11 in. x 6.30 in.

Performance Data

Size	Model	Distribution	Wattage	Lumen Output	Efficacy	BUG Rating	CCT	L70 Calculated Life
37	375W	Type 2	385.8W	59,400.0	154.0 LPW	B5-U0-G4	5000K	≥167,000 Hours
		Type 3	351.1W	52,627.0	150.0 LPW	B5-U0-G4	5000K	≥167,000 Hours
		Type 4	386.8W	54,742.0	141.5 LPW	B5-U3-G5	5000K	≥167,000 Hours
		Type 5	357.9W	53,777.0	150.3 LPW	B5-U0-G5	5000K	≥167,000 Hours
50	500W	Type 2	515.6W	77,642.0	150.6 LPW	B5-U0-G5	5000K	≥167,000 Hours
		Type 3	491.0W	73,933.0	150.6 LPW	B5-U0-G5	5000K	≥167,000 Hours
		Type 4	513.5W	76,406.0	148.8 LPW	B5-U4-G5	5000K	≥167,000 Hours
		Type 5	512.3W	77,006.0	150.3 LPW	B5-U0-G5	5000K	≥167,000 Hours

Optical Distributions

All photometric testing performed to IESNA LM-79 standards by a NVLAP® accredited testing facility. ISO footcandle plots below demonstrate examples of the general distribution patterns based on a 25' mounting height. Please visit www.usled.com for complete specifications, IES files, and detailed photometric data.

Type II Distribution

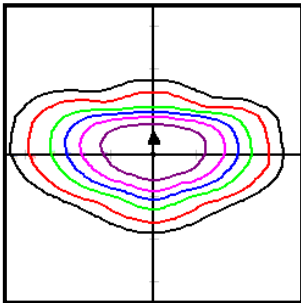

Type II distribution forms a wide, lateral asymmetric pattern typically used for applications needing narrow lighting. Examples might include car lot front rows, walkways, side streets, jogging paths, and entrances from the roadway.

Type III Distribution

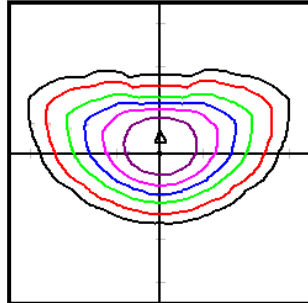

Type III distribution projects light evenly and equally forward on both sides in an "asymmetric" pattern. Commonly used in parking lots, wider roadways, and other applications where a larger area of lighting is required.

Type IV Distribution

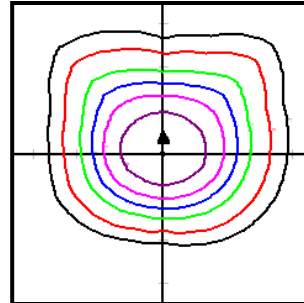

Type IV distribution is intended to maximize the amount of light going forward in a longer "semicircular" pattern. This optic is used around the perimeters of parking lots where there is no desire for wasted light behind the pole. It's also used for sport applications and parking areas on the sides of buildings.

Type V Distribution

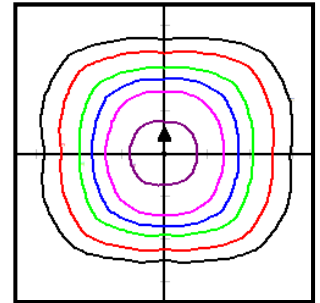

Type V distribution forms a symmetrical round or square pattern that allows the light to have the same intensity at all angles. Primarily used in parking lot interiors, crossroads, and roadway centers. It is also meant for large commercial parking lots where evenly distributed lighting is necessary.

The RCAL's optional rotatable optics offer versatility to design around the specific characteristics of the site layout rather than being constrained by the limitations of the LED luminaire. It's recommended that US LED create a photometric layout that specifies luminaire placement and indicates where rotatable optics are applied.

90° Left Orientation Top View

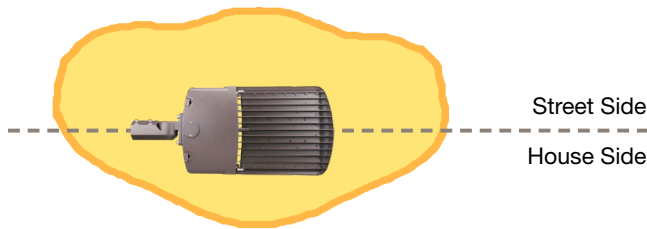

90° Right Orientation Top View

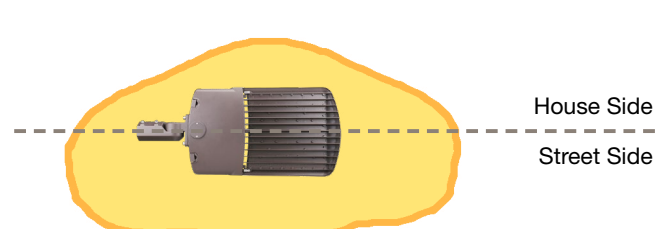

Mounting Accessories

DM | Mount for Square Pole & Round Pole - 4" Nominal



YM | Trunnion Mount



AM | Adjustable Slip Fitter Mount



ADM | Mount For 2 3/8" Round Tenon



Direct Mount Bolt Pattern

