

# L-Grid® Edge Xtreme XL Select

Backlit Flat Panel | Selectable Wattage & CCT

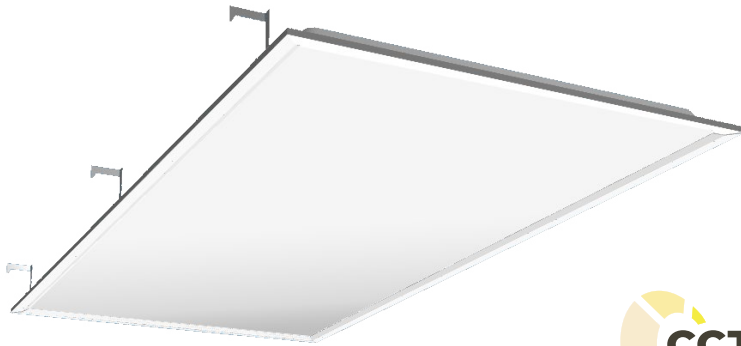

## Key Features

- Energy-efficient LED replacement for existing recessed fluorescent luminaires.
- Select wattage and correlated color temperature (CCT) via a switch in the field.
- Recessed or surface mounted with accessory.
- Bi-level microwave sensor accessory available to integrate with the luminaire.

## Electrical

- 120-277VAC 50/60Hz input.
- Power Factor: >0.9; THD: <20%
- 0-10V dimming standard.
- Operating temperature: -30°C to +45°C (-22°F to +113°F)

## Mounting

- Integral T-bar clips included for mounting in a recessed ceiling application.
- Flange kit accessory available (consult factory).

## Construction

- Extruded aluminum frame with steel backing prevents light leak and is built for superior strength and durability.
- Frosted white lens offers complete shielding and uniform light distribution that's glare-free.
- Low-profile design provides flexibility for installing in low plenum areas (non-IC rated).

## Optics

- Uniform illumination with no visible bright spots or pixelation.
- Industry-leading LEDs with selectable CCT via switch in the field: 3500K, 4000K, and 5000K CCT (minimum 80 CRI).
- Lumen Maintenance: >50,000 hours (L70) <sup>1</sup>

## Warranty

- Backed by US LED's Five-Year Warranty.

## Ordering Information

Series	Size	Input Voltage	Selectable Power	Selectable CCT
<b>FTR3</b>				
<b>14</b>	1x4	<b>UNVL</b> 120-277V	<b>26<sup>2</sup></b> 26W, 32W, 40W	<b>SCCT</b> Selectable CCT: 3500K, 4000K, & 5000K
<b>22</b>	2x2		<b>32<sup>2</sup></b> 32W, 40W, 50W	
<b>24</b>	2x4			

Project	Date
---------	------

Catalog Number	Type
----------------	------

## Product Performance Summary

<b>Lumen Output</b>	Up to 7,189 lumens
<b>Efficacy</b>	Up to 156 LPW
<b>CRI</b>	≥ 80 CRI
<b>Available CCT</b>	Selectable CCT 3500K, 4000K & 5000K
<b>Warranty</b>	Five-Year Warranty

## Product Overview

Designed with both the end-user and contractor in mind, the L-Grid® Edge Xtreme XL Select packages the right combination of features to balance project requirements and occupant well-being. These backlit flat panels offer the ability to select a preferred wattage and CCT in the field, simplifying lighting design and reducing inventory. More than just light, they are engineered to bring superior visual comfort to retail stores and offices while accelerating installation.

## Product Applications

- Classrooms
- Conference Rooms
- Office Spaces
- Hallways/Corridors
- Industrial/Warehouses
- Convenience Stores
- Retail Areas
- Hospitals
- Health Care Facilities
- Commercial Spaces

## Product Certifications

- UL Listed
- Complies with UL 1598 and CSA 22.2
- Suitable for Indoor Damp Locations
- DLC Premium Listed
- NSF Certified
- RoHS Compliant



Example: **FTR3-24-UNVL-32-SCCT**

Accessories	
<b>BLS</b>	Bi-Level Microwave Sensor
<b>BBU</b>	Battery Backup
<b>FTR3-SMK14</b>	1x4 Surface Mount Kit
<b>FTR3-SMK22</b>	2x2 Surface Mount Kit
<b>FTR3-SMK24</b>	2x4 Surface Mount Kit

1. Product 'Lifetimes' refer only to the LED light engine, not the power source, and are based on the Illuminating Engineering Society's TM21 Projected Lumen Maintenance methodology at a 25° C / 77° F ambient temperature. The lifetimes are solely meant to be a guide for expected LED degradation and not a warranty or predictive of their actual life, which can be affected by ambient temperatures and other factors.  
2. [Option 26] only available with 1x4 and 2x2 models. [Option 32] only available with 2x4 model.

# L-Grid® Edge Xtreme XL Select

Backlit Flat Panel with Selectable CCT



## Dimensions

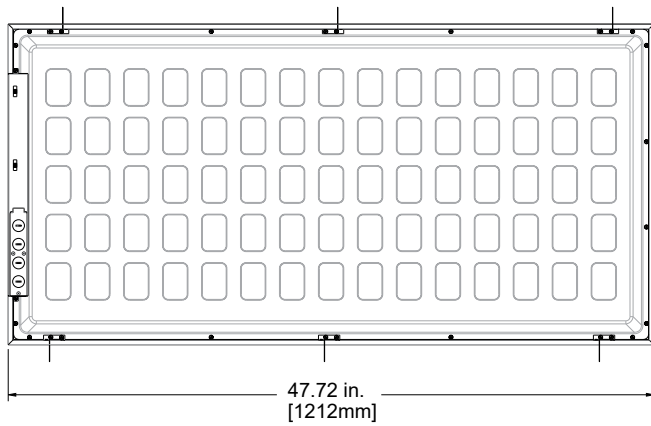

2x4 Model

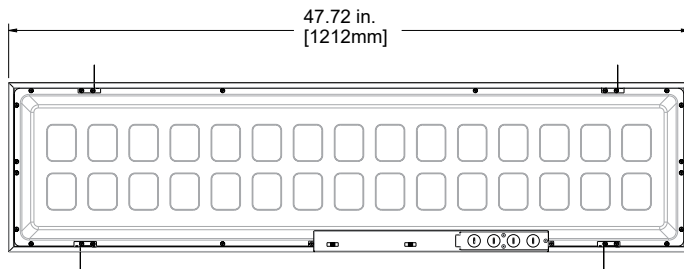
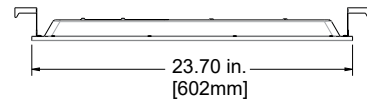
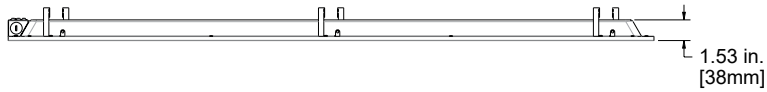
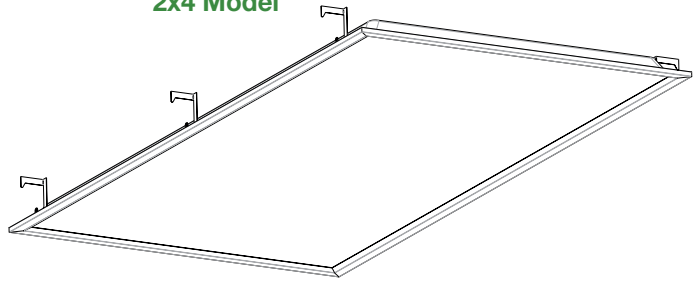

1x4 Model

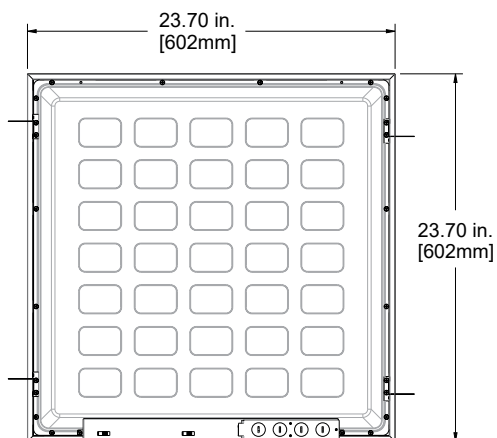
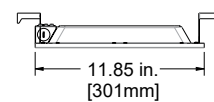
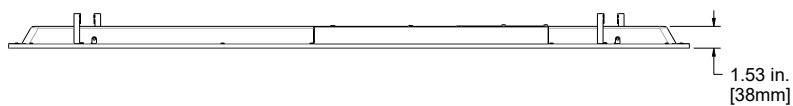
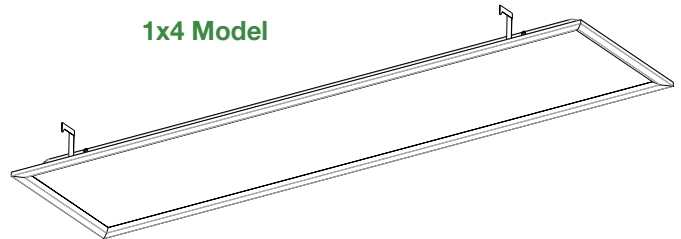

2x2 Model

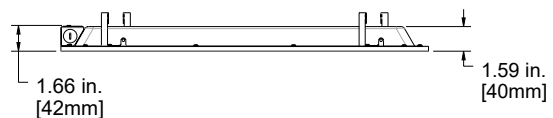
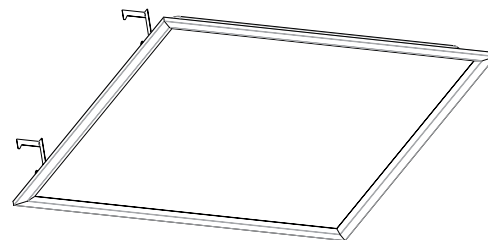

# L-Grid® Edge Xtreme XL Select

Backlit Flat Panel with Selectable CCT



## Performance Data

Model	System Level Power	Delivered Lumens	Efficacy	CCT	L70 Calculate Life
FTR3-14-UNVL-XX-SCCT	26.6W	3,561	133.9 LPW	3500K	>50,000 Hours
	25.5W	3,784	148.4 LPW	4000K	>50,000 Hours
	26.4W	3,646	138.1 LPW	5000K	>50,000 Hours
	32.7W	4,221	129.1 LPW	3500K	>50,000 Hours
	31.8W	4,582	144.1 LPW	4000K	>50,000 Hours
	32.7W	4,341	132.8 LPW	5000K	>50,000 Hours
	40.0W	4,941	123.5 LPW	3500K	>50,000 Hours
	39.2W	5,473	139.6 LPW	4000K	>50,000 Hours
	40.0W	5,080	127.0 LPW	5000K	>50,000 Hours
FTR3-22-UNVL-XX-SCCT	26.3W	3,557	135.2 LPW	3500K	>50,000 Hours
	25.2W	3,798	150.7 LPW	4000K	>50,000 Hours
	26.1W	3,634	139.2 LPW	5000K	>50,000 Hours
	31.7W	4,145	130.8 LPW	3500K	>50,000 Hours
	30.8W	4,521	146.8 LPW	4000K	>50,000 Hours
	31.8W	4,260	134.0 LPW	5000K	>50,000 Hours
	39.5W	4,886	123.7 LPW	3500K	>50,000 Hours
	37.7W	5,378	142.7 LPW	4000K	>50,000 Hours
FTR3-24-UNVL-XX-SCCT	39.4W	5,009	127.1 LPW	5000K	>50,000 Hours
	31.5W	4,609	146.3 LPW	3500K	>50,000 Hours
	30.5W	4,857	159.2 LPW	4000K	>50,000 Hours
	31.2W	4,796	153.7 LPW	5000K	>50,000 Hours
	38.3W	5,540	144.6 LPW	3500K	>50,000 Hours
	37.3W	5,838	156.5 LPW	4000K	>50,000 Hours
	38.5W	5,704	148.2 LPW	5000K	>50,000 Hours
	48.8W	6,766	138.6 LPW	3500K	>50,000 Hours
	47.2W	7,189	152.3 LPW	4000K	>50,000 Hours
48.8W	6,957	142.6 LPW	5000K	>50,000 Hours	

# L-Grid® Edge Xtreme XL Select

Backlit Flat Panel with Selectable CCT



## Accessories

**FTR3-SMK14** L-Grid Edge Xtreme Select 1x4 Surface Mount Kit

**FTR3-SMK22** L-Grid Edge Xtreme Select 2x2 Surface Mount Kit

**FTR3-SMK24** L-Grid Edge Xtreme Select 2x4 Surface Mount Kit

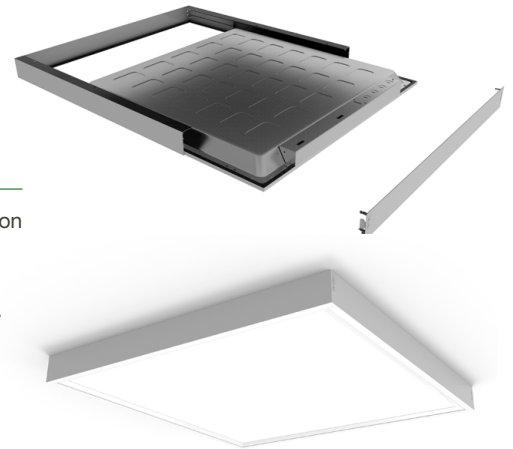

## Overview

These kit accessories allow for the FTR3 L-Grid Edge Xtreme XL Select to be field installed in plenum-less spaces. Designed for use on the surface of drywall or concrete ceilings, these surface mount kits are ideal for offices, educational facilities, healthcare facilities, and any other indoor applications where surface mount troffer installation is required. The FTR3-SMK is available in 1x4, 2x2, or 2x4 configurations.

## Key Features

- Surface mounted kits that facilitate easy installation of recessed troffers in non-plenum spaces.
- Available in 1x4, 2x2, or 2x4 configurations.
- Tool-free kit assembling reduces installation time.
- Extruded aluminum construction with white powder coat finish ensures maximum protection against potential rust.
- Formed edges are smooth for safe handling.

## Specifications

**FTR3-SMK24**

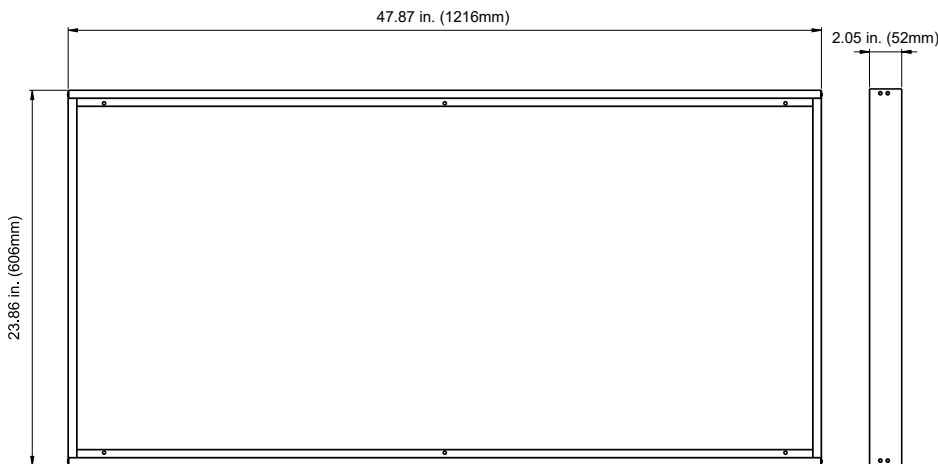

**FTR3-SMK22**

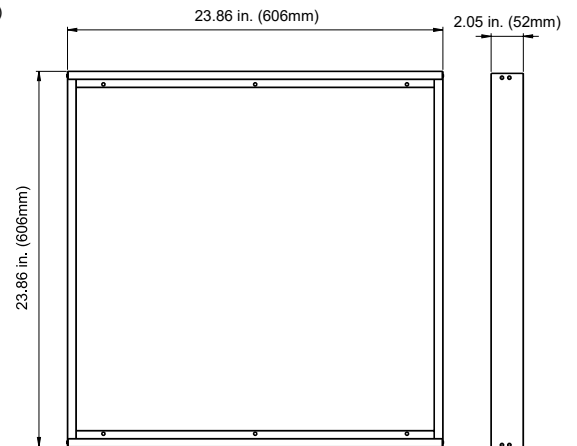

**FTR3-SMK14**

