



IMPORTANT SAFETY WARNINGS



THE INSTALLATION MUST ONLY BE PERFORMED BY A LICENSED ELECTRICIAN. TO PREVENT DEATH, INJURY OR DAMAGE TO PROPERTY, THIS PRODUCT MUST BE INSTALLED IN ACCORDANCE TO NATIONAL ELECTRIC CODE (NFPA70) IN THE US OR CANADIAN ELECTRICAL CODE (CSA22.1) IN CANADA.

L'INSTALLATION NE DOIT ÊTRE EFFECTUÉE QUE PAR UN ÉLECTRICIEN AGRÉÉ. POUR PRÉVENIR LES DÉCÈS, LES BLESSURES OU LES DOMMAGES MATÉRIELS, CE PRODUIT DOIT ÊTRE INSTALLÉ CONFORMÉMENT AU CODE NATIONAL DE L'ÉLECTRICITÉ (NFPA70) AUX USA OU CODE CANADIEN DE L'ÉLECTRICITÉ (CSA22.1) AU CANADA.

CONSULT A QUALIFIED ELECTRICIAN TO ENSURE CORRECT BRANCH CIRCUIT CONDUCTOR.

CONSULTER UN ÉLECTRICIEN QUALIFIÉ POUR VOUS ASSURER QUE LES CONDUCTEURS DE LA DÉRIVATION SONT ADÉQUATS.

SUITABLE FOR DAMP LOCATIONS. SUITABLE FOR OPERATION IN AMBIENT NOT EXCEEDING 45°C (113°F).

CONVIENT AUX EMPLACEMENTS HUMIDES. PEUT ÊTRE UTILISÉ À UNE TEMPÉRATURE AMBIANTE N'EXCÉDANT PAS 45°C (113°F).

CAUTION – RISK OF FIRE. MIN 90°C (194°F) SUPPLY CONDUCTORS.

ATTENTION – RISQUE D'INCENDIE. LES FILS D'ALIMENTATION 75°C (167°F) MIN.

- To reduce the risk of death, personal injury or property damage from fire, electric shock, falling parts, cuts/abrasions, and other hazards please read all warnings and instructions included with and on the fixture box and all fixture labels.
- Follow all manufacturer's warnings, recommendations and restrictions for: driver type, burning position, mounting locations/ methods, replacement and recycling.
- Wear gloves and safety glasses at all times when removing luminaire from carton, installing, servicing or performing maintenance.
- Disconnect power before installation or servicing the LED luminaire.
- Allow lamp/fixture to cool before handling.
- Do not exceed maximum wattage marked on the label.
- Do not operate in close proximity to persons, combustible materials or substances affected by heat or drying.
- Verify that supply voltage is correct by comparing it with the label information.
- Wiring connections should be capped with UL-approved wire connectors.
- DO NOT INSTALL DAMAGED PRODUCT! This luminaire has been properly packed so that no parts should have been damaged during transit. Inspect to confirm. Any part damaged during or after assembly should be replaced.
- Maintenance of the luminaires should be performed by person(s) familiar with the luminaires' construction and operation and any hazards involved. Regular fixture maintenance programs are recommended.
- It will occasionally be necessary to clean the outside of the refractor/lens. Frequency of cleaning will depend on ambient dirt level and minimum light output which is acceptable to user. Refractor/lens should be washed in a solution of warm water and any mild, non-abrasive household detergent, rinsed with clean water and wiped dry.
- Should optical assembly become dirty on the inside, wipe refractor/lens and clean in above manner, replacing damaged gaskets as necessary.
- These instructions do not purport to cover all details or variations in equipment nor to provide every possible contingency to meet in connection with installation, operation, or maintenance.

Specifications and dimensions subject to change without notice.

PRODUCT INFORMATION

With a low-profile, stay-white acrylic diffuser, the SCL1 provides general illumination for commercial applications such as self-storage units, utility areas, workrooms, closets, and other small rooms needing general lighting. The SCL1 is available in a 9" round model and offers selectable wattage options.

FRONT VIEW

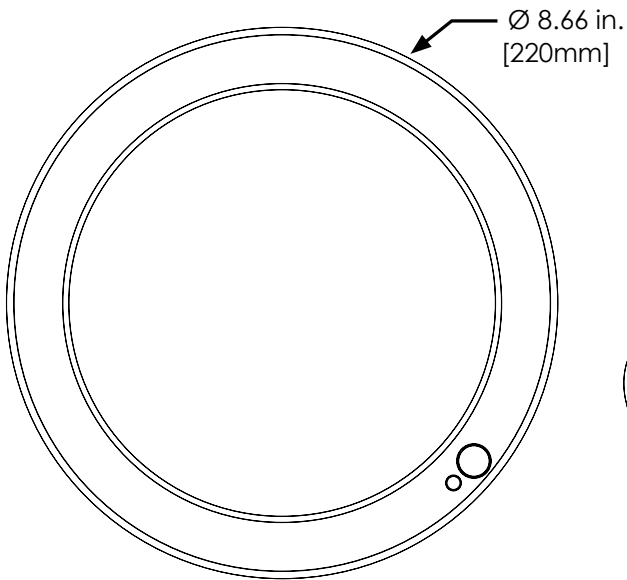

SIDE VIEW

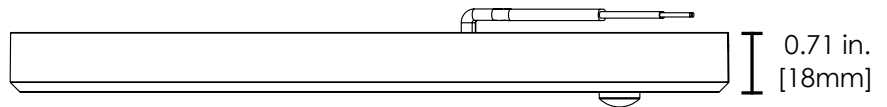

ISO VIEW

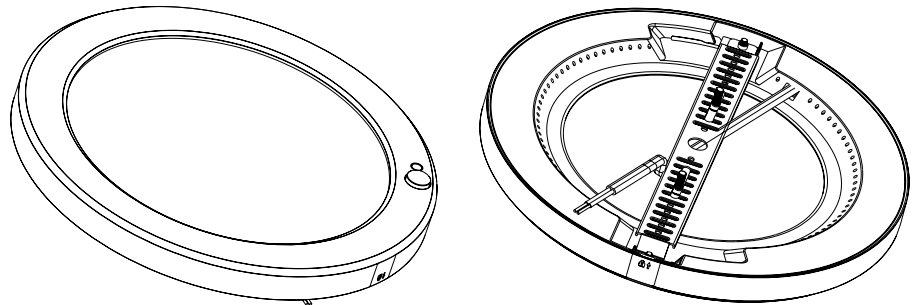

Specifications and dimensions subject to change without notice.

SURFACE MOUNTING INSTRUCTIONS

1. Remove the trim ring from the fixture, by gentle pulling outward on the trim ring and pushing the fixture apart. (Be careful not to pull until part is broken).
2. Separate body of fixture from light cavity.
3. Remove the mounting bracket from the fixture by turning counterclockwise. Attach the bracket onto the junction box with screws, feed fixture supply wire through the middle hole of the mounting bracket (Figure 1).
4. Connect the ground wire to the green screw on the bracket.
5. Connect the supply wire from the fixture to the in coming supply wire MAIN VOLTAGE SUPPLY WIRE TO BLACK LUMINAIRE WIRE NEUTRAL (COMMON) SUPPLY WIRE TO WHITE LUMINAIRE WIRE.
6. Place the fixture over the mounting bracket and turn clockwise until the fixture clicks, approximately 1/8 turn. If not using an existing J-Box, use screws to mount fixture to the ceiling (Figure 2).
7. Install surface cover to light body. Ensure lock marks are matched and sensor openings align (Figure 3).
8. Turn power on and verify fixture lights properly (Figure 4).

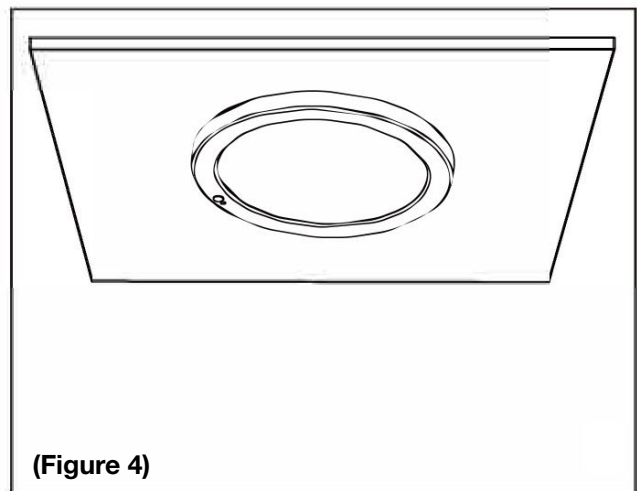
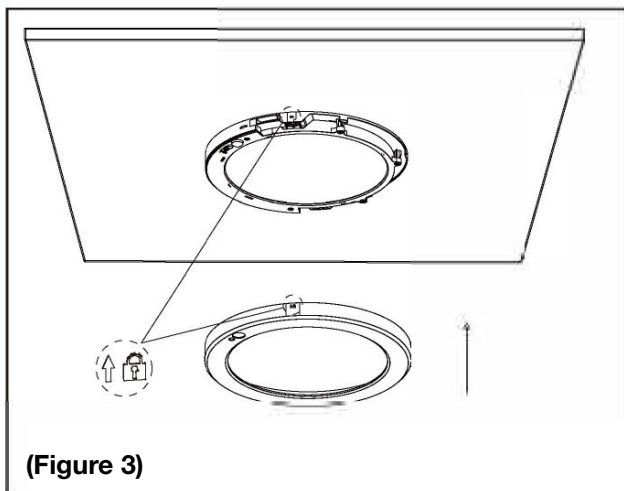
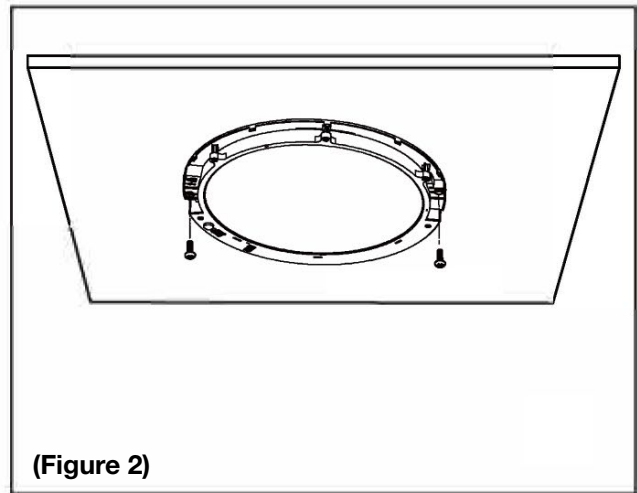
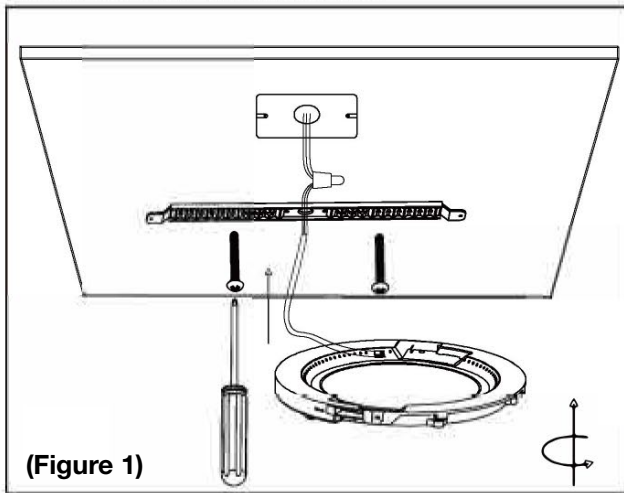

Specifications and dimensions subject to change without notice.

WATTAGE SELECTION AND SENSOR PROGRAMMING

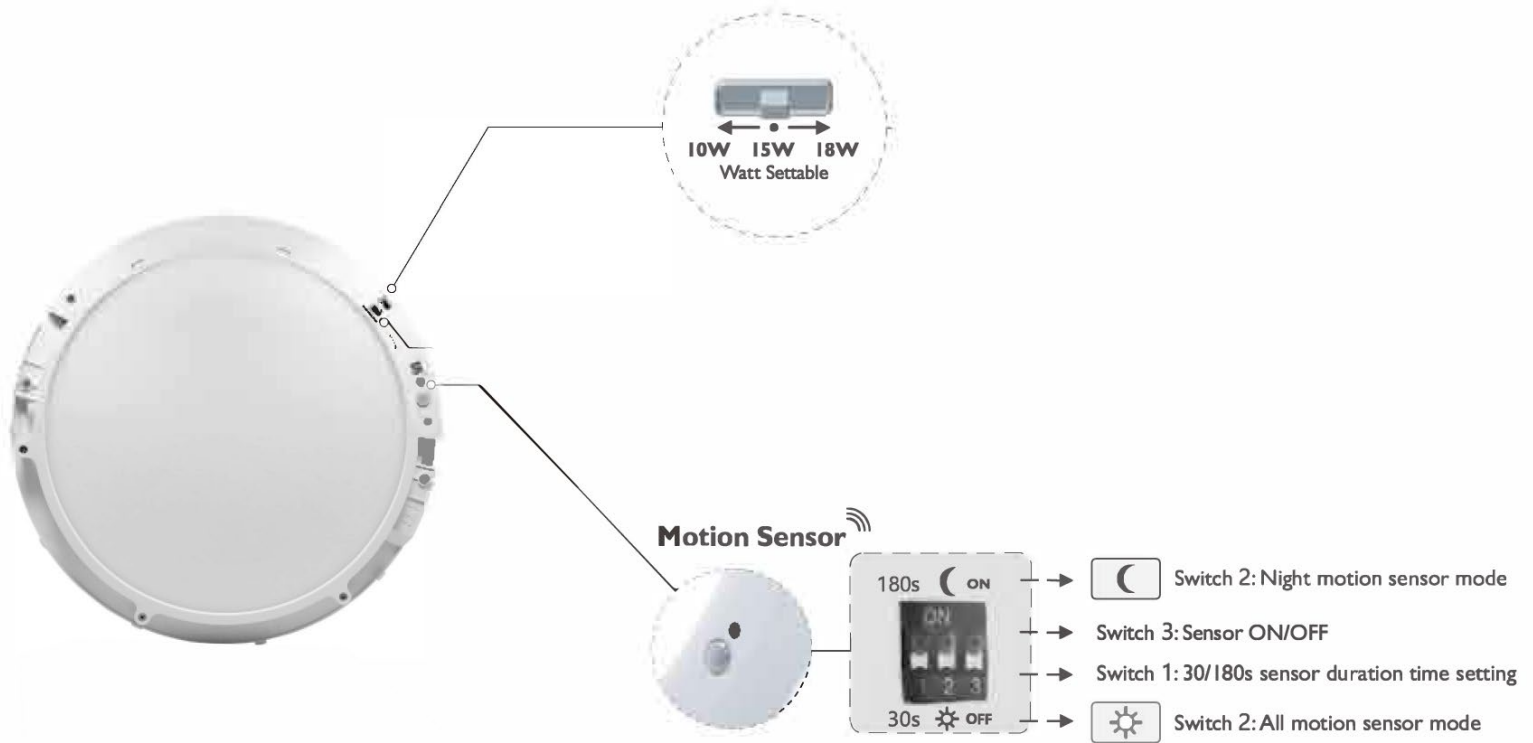

Specifications and dimensions subject to change without notice.